



IZI
Estruturas



17 3283-2018

MANUAL DE MONTAGEM
KIT PRISIONEIRO ESTRUTURA MADEIRA

TELHADO ESTRUTURA MADEIRA

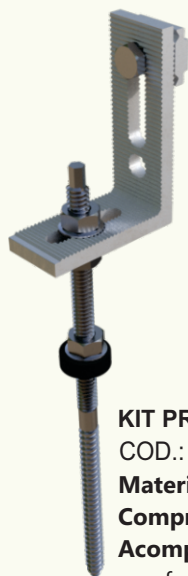

KIT PRISIONEIRO ESTRUTURA MADEIRA

COD.: IZI420

Material: Alumínio 6060-T5 | Inox

Comprimento: 250mm

Acompanha: Uma haste inox 10mm, um parafuso sextavado, uma porca quadrada, borracha para vedação, três porcas inox e suporte para trilho.

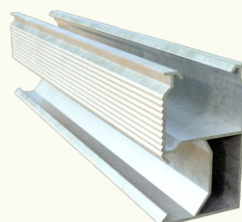

PERFIL C

COD.: IZI050

Material: Alumínio 6060-T5

Distância máx. entre apoios: 1,50m

Tamanho disponível: 2,40m e 4,80m

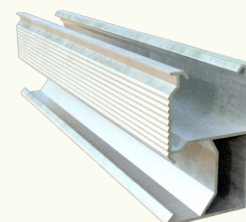

PERFIL C

COD.: IZI003

Material: Alumínio 6060-T5

Distância máx. entre apoios: 1,80m

Tamanho disponível: 2,40m e 4,80m

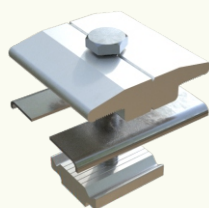

GRAMPO INTERMEDIÁRIO

COD.: IZI 200

Material: Alumínio 6005-T5 | Inox 304

Altura: 30 à 40mm

Acompanha: Parafuso Sextavado inox, porca de alumínio e chapa de contato de inox (para aterramento)

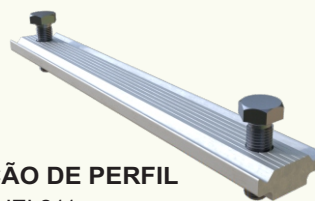

JUNÇÃO DE PERFIL

COD.: IZI 211

Material: Alumínio 6060-T5 | Inox 304

Tamanho: 15cm

Acompanha: Dois parafusos sextavados de inox.

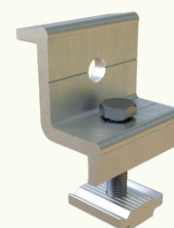

GRAMPO FINAL

COD.: IZI 201

Material: Alumínio 6005-T5 | Inox 304

Altura: 30 à 40mm

Acompanha: Parafuso Sextavado inox e porca de alumínio.

MONTAGEM PASSO A PASSO

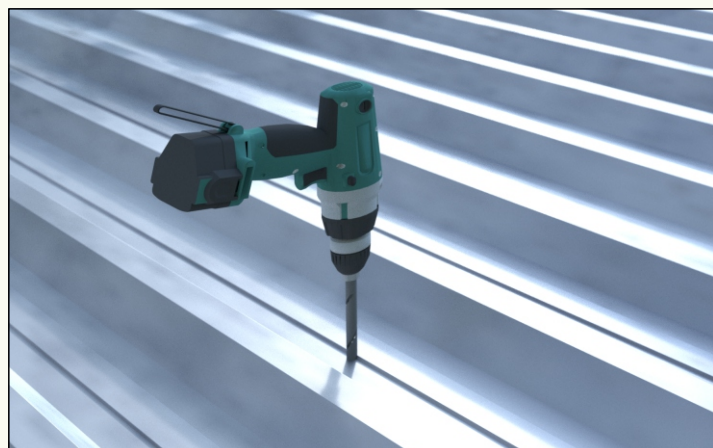

● Furar a telha metálica e a estrutura com broca 9,3mm.

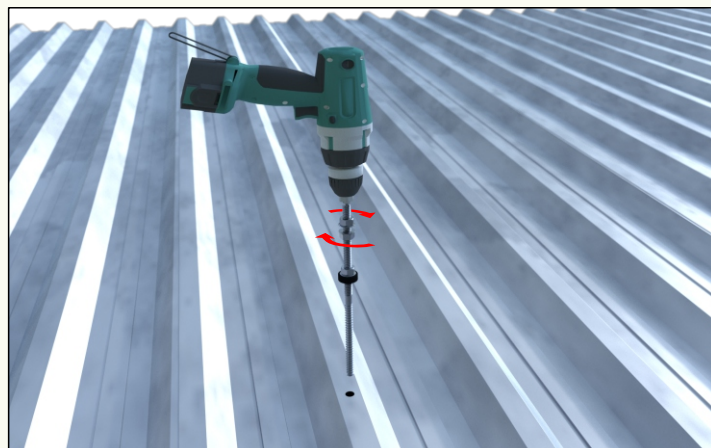

● Parafusar a Haste na estrutura.

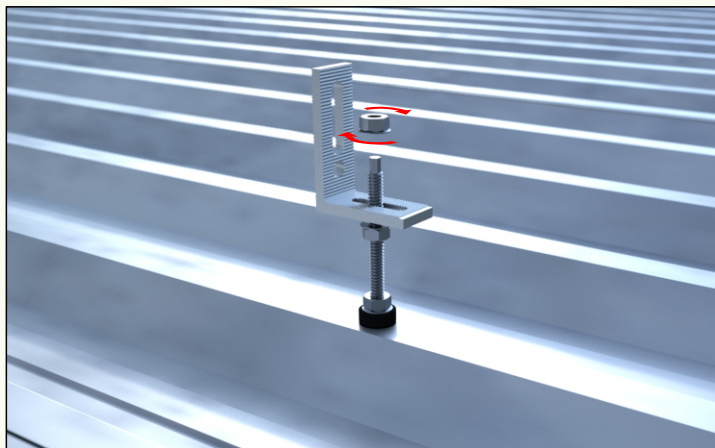

- Fixar o Suporte L com a porca flangeada.

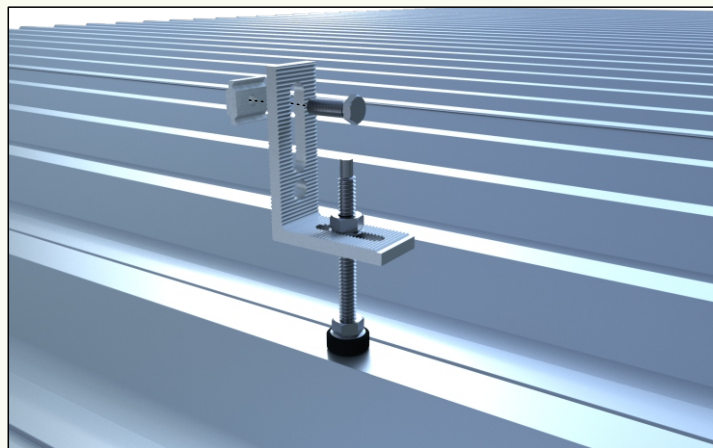

- Colocar o Parafuso sextavado e a porca de alumínio.

FIXAÇÃO DO SUPORTE L NO PERFIL C

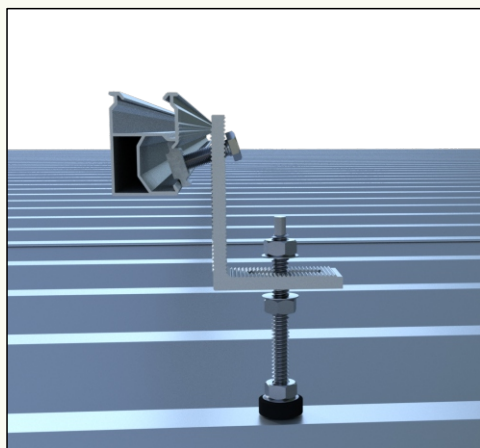

- Inclinando o parafuso para facilitar o encaixe no perfil C.

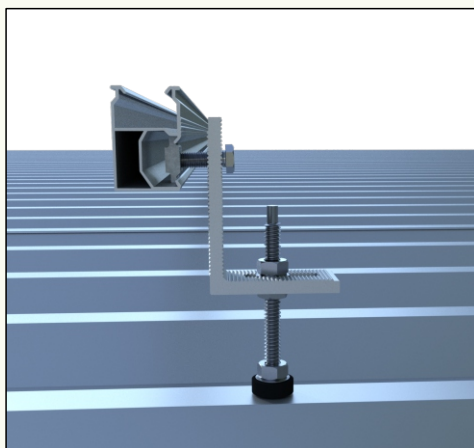

- Depois de encaixado dentro do perfil C, apertar o parafuso sextavado.

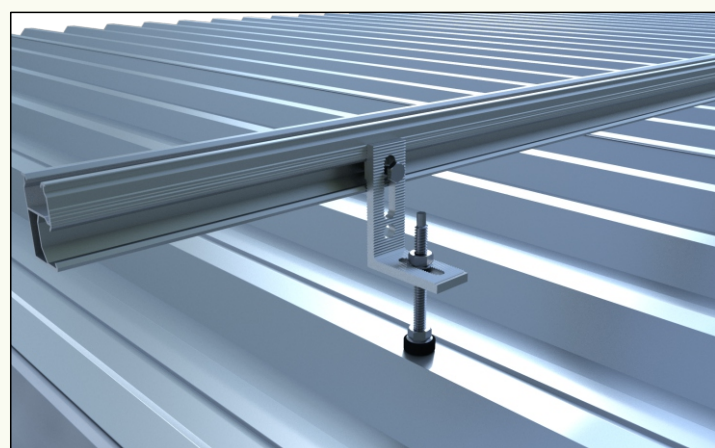
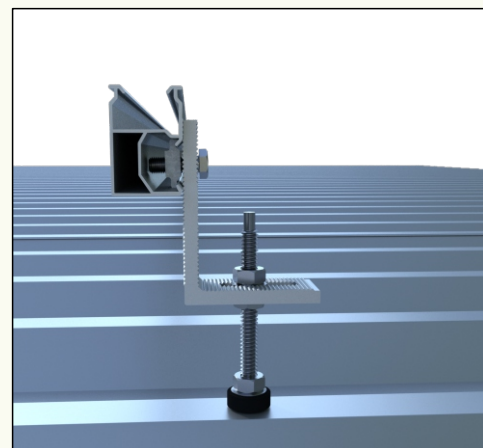

- Kit prisioneiro instalado.

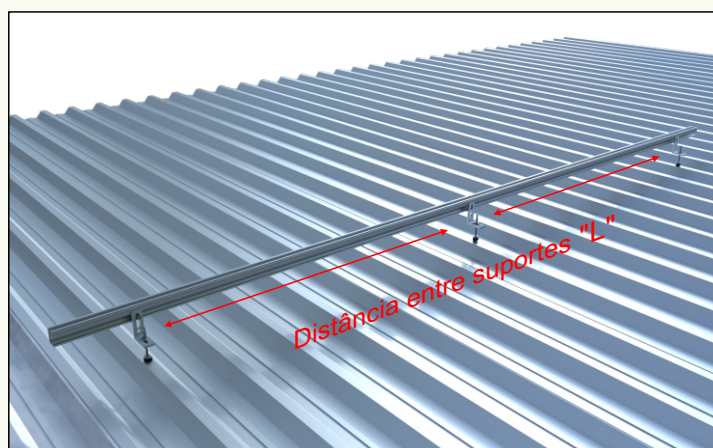

- Distância recomendada entre os Suportes "L":
 Perfil IZI 003 - 1,80mts
 Perfil IZI 050 - 1,50mts

FIXAÇÃO GRAMPO FINAL

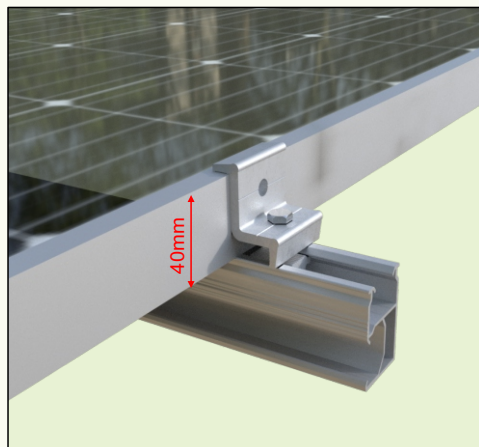

- Grampo final com regulagem para módulos de 40mm de altura.

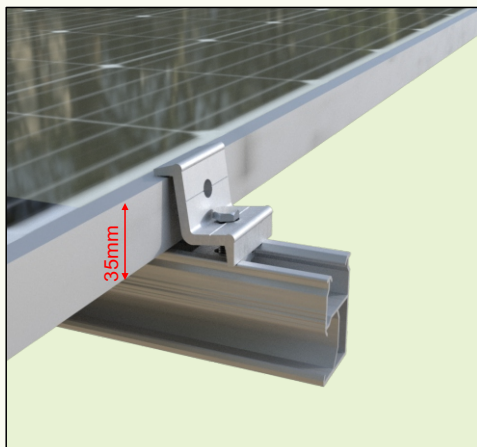

- Grampo final com regulagem para módulos de 35mm de altura.

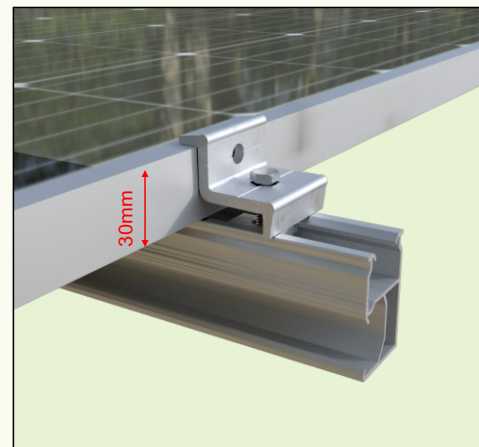

- Grampo final com regulagem para módulos de 30mm de altura.

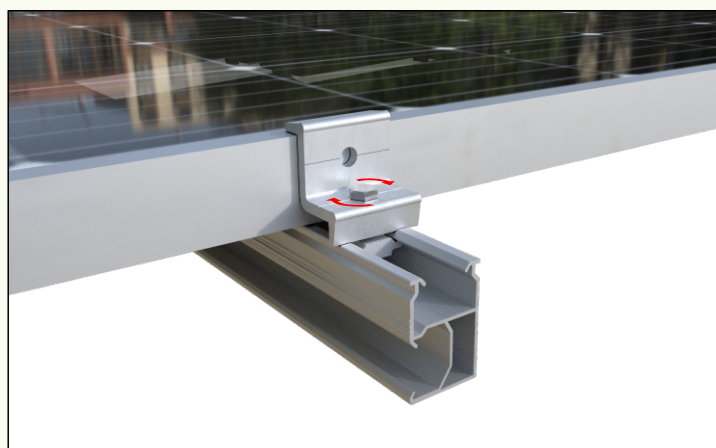

- Fixar o grampo final com parafuso sextavado de inox.

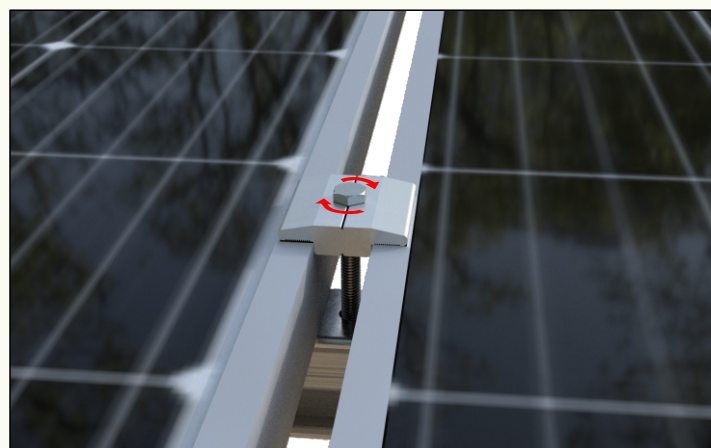

- Fixar o grampo intermediário com parafuso sextavado de inox.

FIXAÇÃO GRAMPO INTERMEDIÁRIO

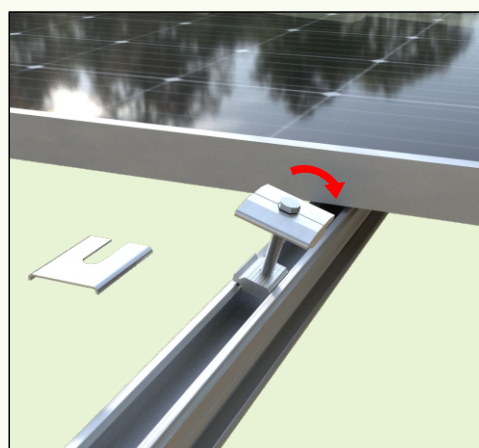

- Girar o grampo intermediário levemente para se encaixar no perfil C.

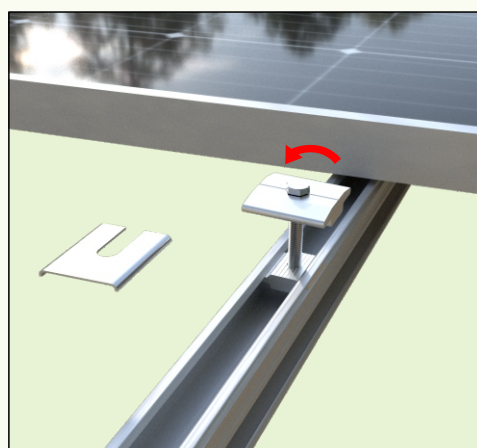

- Após ser encaixado empurrar até o módulo já posicionado, sem apertar.

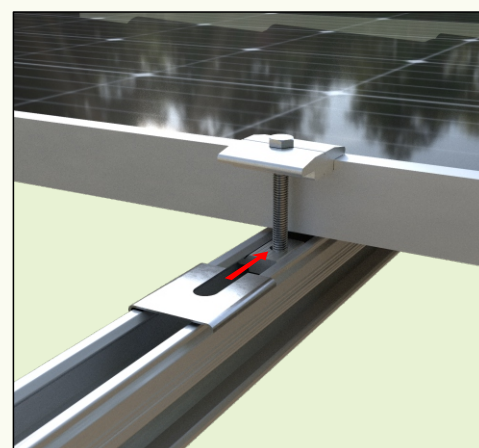



- Colocar a chapa de aterramento sob o módulo.



Izi Industrial LTDA

www.iziestrutas.com.br

 @iziestrutas

 17 3283-2018 / 99738-1651